



JSP BRAKES & CLUTCHES

COMPANY

PROFILE

**PREMIUM BRAKING SOLUTIONS FOR
2W APPLICATIONS**

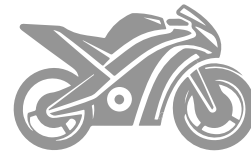
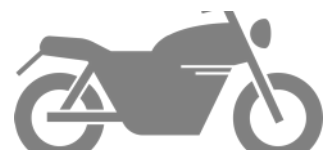
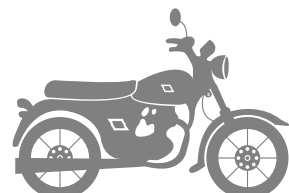

TRUSTED BY DEALERS & MECHANICS ACROSS INDIA

Table of **CONTENTS**

Contents

ABOUT

OUR TEAM

VISION

MISSION

WHY CHOOSE JSP BRAKES

MANUFACTURING

OUR ACHIEVEMENT

2W DISC PADS RANGE START

2W SCOOTER & EV RANGE START

Page No®

3

4

5

6

7

8

9

10

24

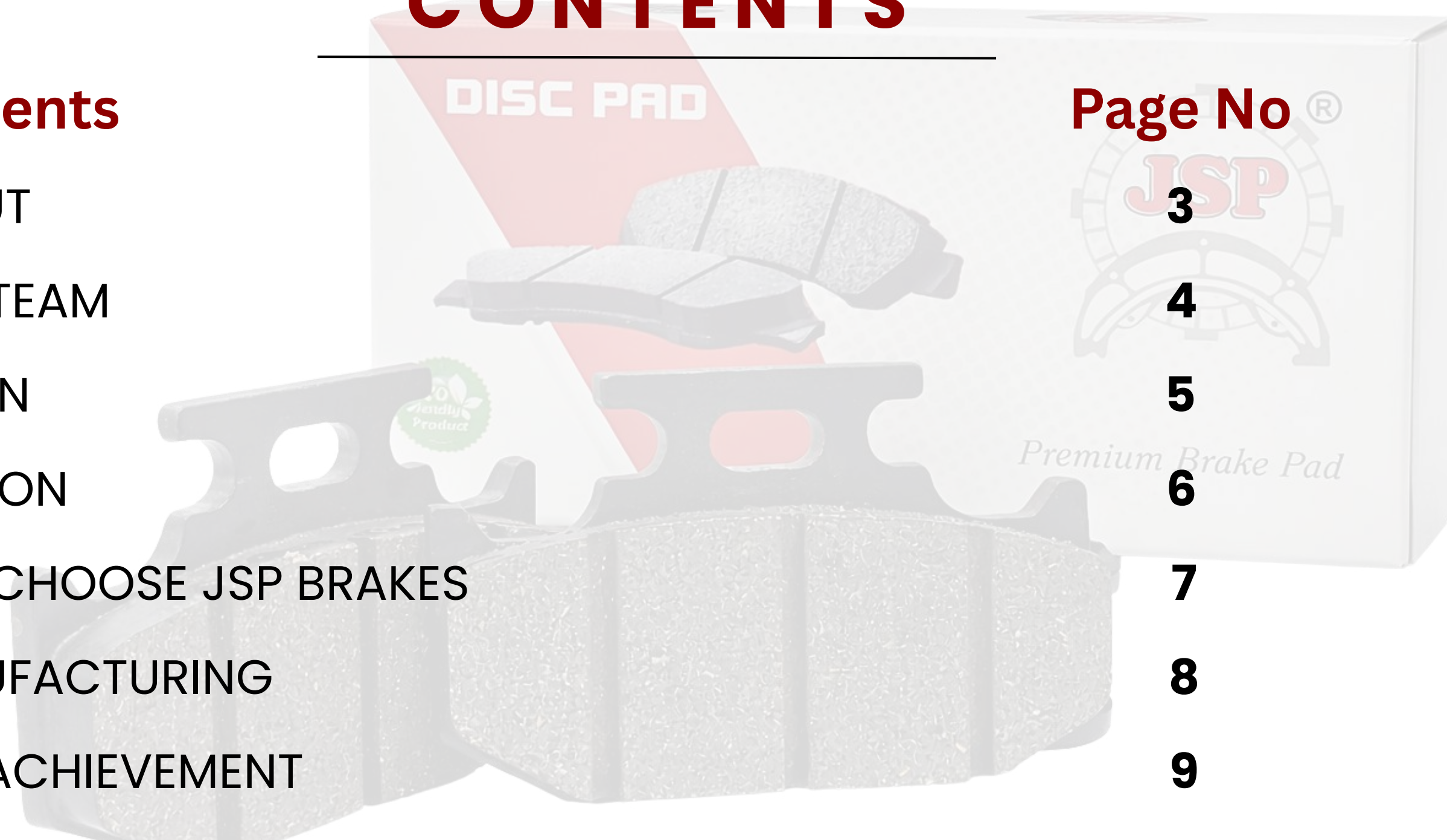

About COMPANY

Established in 1998 in Delhi, JSP Automotive Pvt. Ltd. (**ISO 9001 : 2015 certified**) manufactures premium two-wheeler braking solutions. We specialize in Brake Shoes, Disc Pads, Clutch Plates, Clutch Shoes for Hero, Tvs, Bajaj, and more.

Our product deliver friction stability, heat resistance, and durability for Indian roads – ensuring smooth stops, reduced wear, and rider safety.

Expanding pan-India and internationally, we prioritize quality, innovation, and timely supply. Trusted by mechanics and distributors nationwide – now exporting worldwide.



Message From The **FOUNDER**

At JSP Brakes & Clutches, our goal has always been to build products that people can rely on every single day.

We understand that braking is not just a component — it is a responsibility. Every product we manufacture carries our commitment to safety, performance, and long-term reliability.

Our journey has been powered by the trust of our dealers, mechanics, and customers. We will continue to innovate, improve, and grow while maintaining the quality standards that define our brand.



**Founder & Managing Director
JSP automotive Pvt. Ltd.**

VISION

Our vision is to establish JSP Brakes as a globally respected two-wheeler braking brand, known for innovation, precision engineering, dependable performance, and enduring customer value in India and beyond.



MISSION

At JSP Brakes, our mission is to deliver dependable two-wheeler braking components through quality manufacturing, continuous improvement, and strong customer trust. We aim to support riders with safer performance, and distributors with products they can rely on across India and international markets.



WHY CHOOSE JSP BRAKES

Engineered for reliable braking performance, long-lasting durability, and consistent rider confidence across daily and demanding road conditions.

- OEM Fitment Accuracy
- High Friction Performance
- Heat-Resistant Material
- Smooth brake Response
- Low Noise Operation
- Long Service Life
- Daily and Highway ready
- Wet and Dry Stability
- Quality-Tested
- Wide Vehicle Compatibility

Manufacturing Process



1

Material Selection

We select premium-grade friction materials to ensure durability, heat resistance, and stable braking performance.

2

Precision Manufacturing

Our advanced manufacturing methods deliver accurate fitment and consistent product quality.

3

Quality Inspection

Every product is tested under strict quality standards for safety, reliability, and long service life.

4

Packaging & Supply

Finished products are carefully packed and dispatched through a reliable dealer and distributor network.

OUR ACHIEVEMENT

JSP Brakes has grown through years of dedicated manufacturing, consistent quality control, and strong customer trust. With a focus on two-wheeler braking components, we continue to expand our product range and market presence across India and international markets.

Years of Experience

1998

Established in Delhi with a focus on two-wheeler braking solutions.

Quality Focus

ISO 9001:2015

Committed to quality-driven manufacturing and reliable performance.

Dealer Trust

Trusted by Dealers & Mechanics

Building long-term confidence through consistent product quality.

Product Range

Brake Shoes, Disc Pads & Clutch Components

Expanding product line for multiple two-wheeler applications.

2W DISC PADS RANGE

Advanced Braking Performance for Motorcycles

Engineered with advanced ceramic and semi-metallic friction technology, JSP Disc Pads are designed to deliver superior stopping power, zero-noise braking, and excellent heat dissipation for high-speed motorcycles.

PERFORMANCE FEATURES

High Friction Coefficient

(0.35 - 0.45 μ)

Maximum Heat Dissipation Tech

Superior Wet & Dry Weather Grip

Stable Braking at High Speed

OEM Fitment Accuracy

Advanced Ceramic / Semi-Metallic

Zero-Noise Braking Formula

Eco-Friendly Asbestos-Free

Compatible Models

APACHE FRONT



JSP BRAKES: ULTIMATE FRICTION TECHNOLOGY
High-Performance Disc Pad for 2W Applications

NON-ASBESTOS, LOW METAL COMPOUND
High Temperature Stability
Excellent Braking Performance

V-SOLT HEAT EXPANSION GROOVE
Reduces Heat Build-up,
Increases Brake Pad Life

Stable μ @ Elevated temperature
LOW NVH

ROBUST CAST IRON BACKING PLATE
High Rigidity, Enhanced Durability

HIGH-STRENGTH ADHESIVE BOND
Zero DeLamination, Strong Durability

PRECISION ENGINEERED | MAKE IN INDIA | LONG SERVICE LIFE

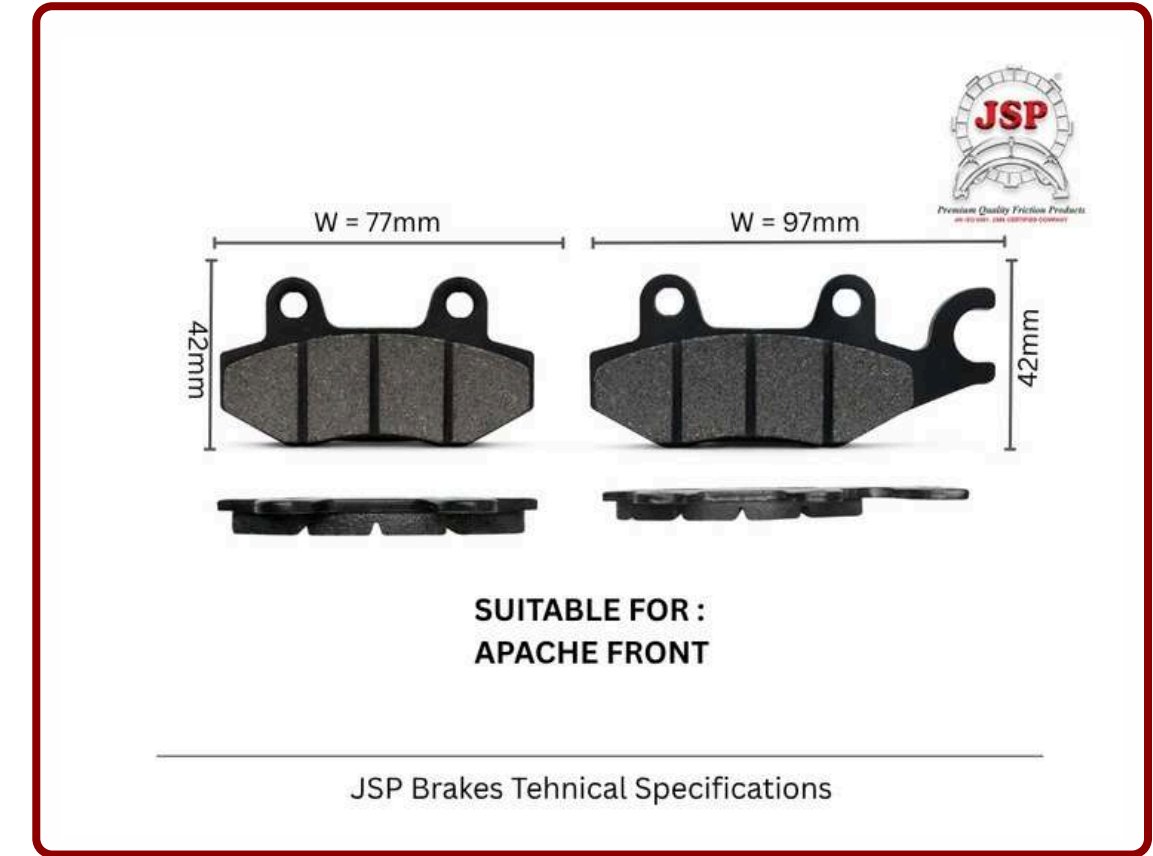

Compatible Models

APACHE REAR



JSP BRAKES: ULTIMATE FRICTION TECHNOLOGY

High-Performance Disc Pad for 2W Applications

- NON-ASBESTOS, LOW METAL COMPOUND**
High Temperature Stability
Excellent Braking Performance
- V-SOLT HEAT EXPANSION GROOVE**
Reduces Heat Build-up,
Increases Brake Pad Life
- Stable μ @ Elevated temperature**
LOW NVH
- ROBUST CAST IRON BACKING PLATE**
High Rigidity, Enhanced Durability
- HIGH-STRENGTH ADHESIVE BOND**
Zero DElamination, Strong Durability

JSP
Premium Quality Friction Products

PRECISION ENGINEERED | MAKE IN INDIA | LONG SERVICE LIFE



Compatible Models

BULLET 350 REAR



JSP BRAKES: ULTIMATE FRICTION TECHNOLOGY

High-Performance Disc Pad for 2W Applications

- NON-ASBESTOS, LOW METAL COMPOUND**
High Temperature Stability
Excellent Braking Performance
- V-SOLT HEAT EXPANSION GROOVE**
Reduces Heat Build-up,
Increases Brake Pad Life
- ROBUST CAST IRON BACKING PLATE**
High Rigidity, Enhanced Durability
- Stable μ @ Elevated temperature**
LOW NVH
- HIGH-STRENGTH ADHESIVE BOND**
Zero DElamination, Strong Durability

PRECISION ENGINEERED | MAKE IN INDIA | LONG SERVICE LIFE

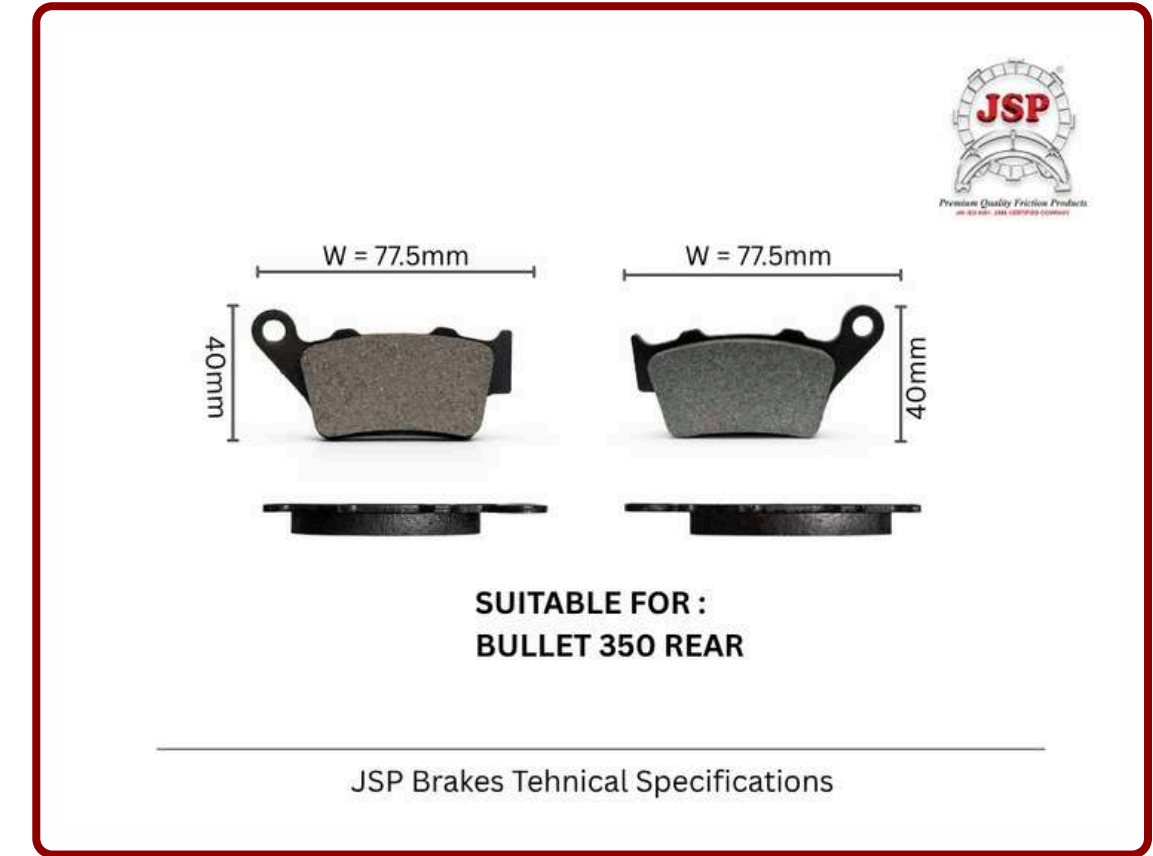

Compatible Models

BULLET CLASSIC 350 FRONT



JSP BRAKES: ULTIMATE FRICTION TECHNOLOGY

High-Performance Disc Pad for 2W Applications

- NON-ASBESTOS, LOW METAL COMPOUND**
High Temperature Stability
Excellent Braking Performance
- V-SOLT HEAT EXPANSION GROOVE**
Reduces Heat Build-up,
Increases Brake Pad Life
- Stable μ @ Elevated temperature**
LOW NVH
- ROBUST CAST IRON BACKING PLATE**
High Rigidity, Enhanced Durability
- HIGH-STRENGTH ADHESIVE BOND**
Zero DElamination, Strong Durability

PRECISION ENGINEERED | MAKE IN INDIA | LONG SERVICE LIFE

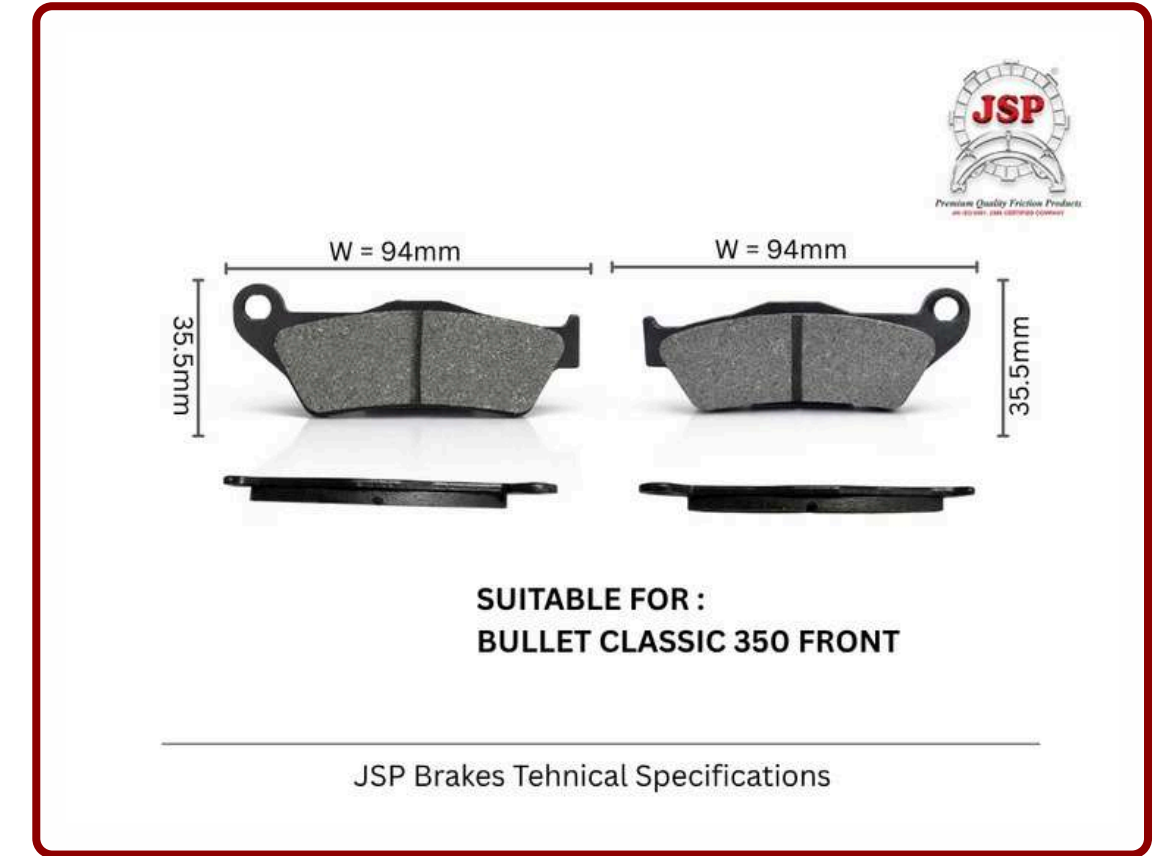

Compatible Models

CBR FRONT



JSP BRAKES: ULTIMATE FRICTION TECHNOLOGY

High-Performance Disc Pad for 2W Applications

- NON-ASBESTOS, LOW METAL COMPOUND**
High Temperature Stability
Excellent Braking Performance
- Stable μ @ Elevated temperature**
LOW NVH
- ROBUST CAST IRON BACKING PLATE**
High Rigidity, Enhanced Durability
- V-SOLT HEAT EXPANSION GROOVE**
Reduces Heat Build-up,
Increases Brake Pad Life
- HIGH-STRENGTH ADHESIVE BOND**
Zero DElamination, Strong Durability

PRECISION ENGINEERED | MAKE IN INDIA | LONG SERVICE LIFE

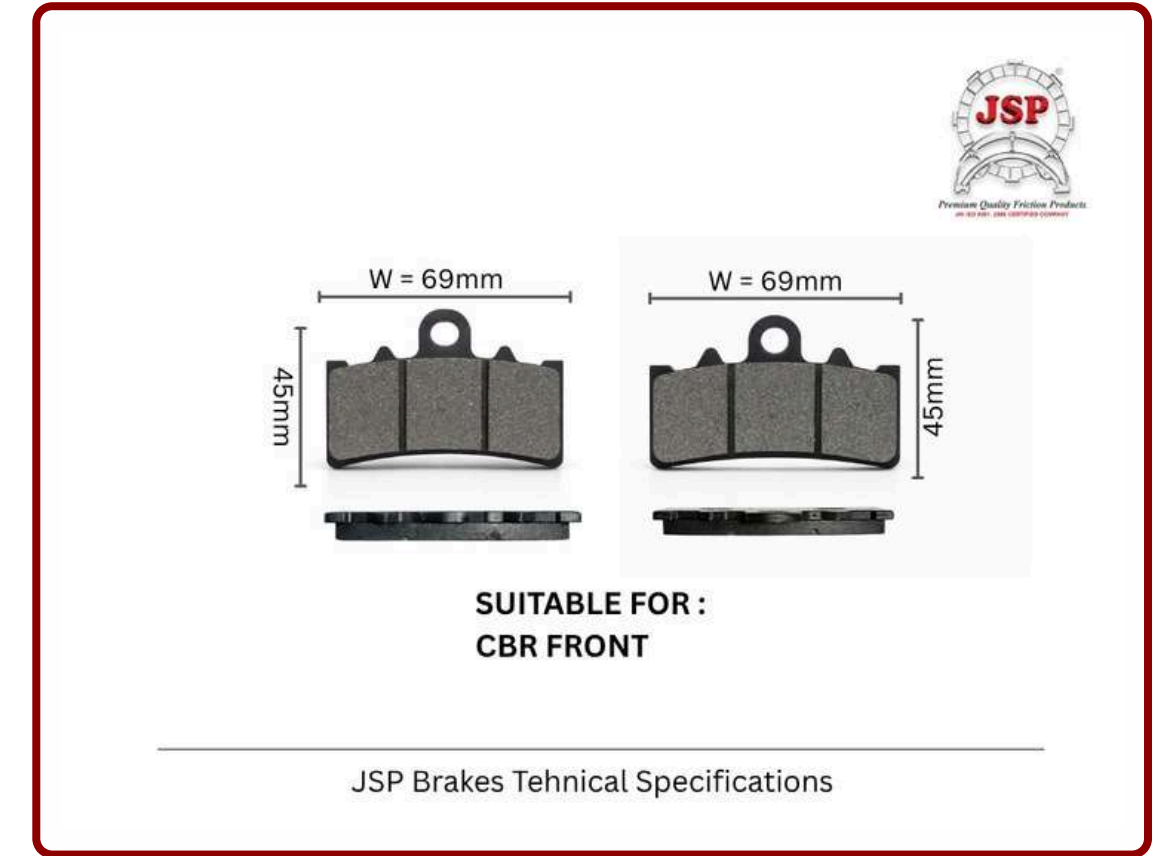

Compatible Models

DAZZLER REAR



JSP BRAKES: ULTIMATE FRICTION TECHNOLOGY

High-Performance Disc Pad for 2W Applications

- NON-ASBESTOS, LOW METAL COMPOUND**
High Temperature Stability
Excellent Braking Performance
- V-SOLT HEAT EXPANSION GROOVE**
Reduces Heat Build-up,
Increases Brake Pad Life
- ROBUST CAST IRON BACKING PLATE**
High Rigidity, Enhanced Durability
- Stable μ @ Elevated temperature**
LOW NVH
- HIGH-STRENGTH ADHESIVE BOND**
Zero DElamination, Strong Durability

PRECISION ENGINEERED | MAKE IN INDIA | LONG SERVICE LIFE

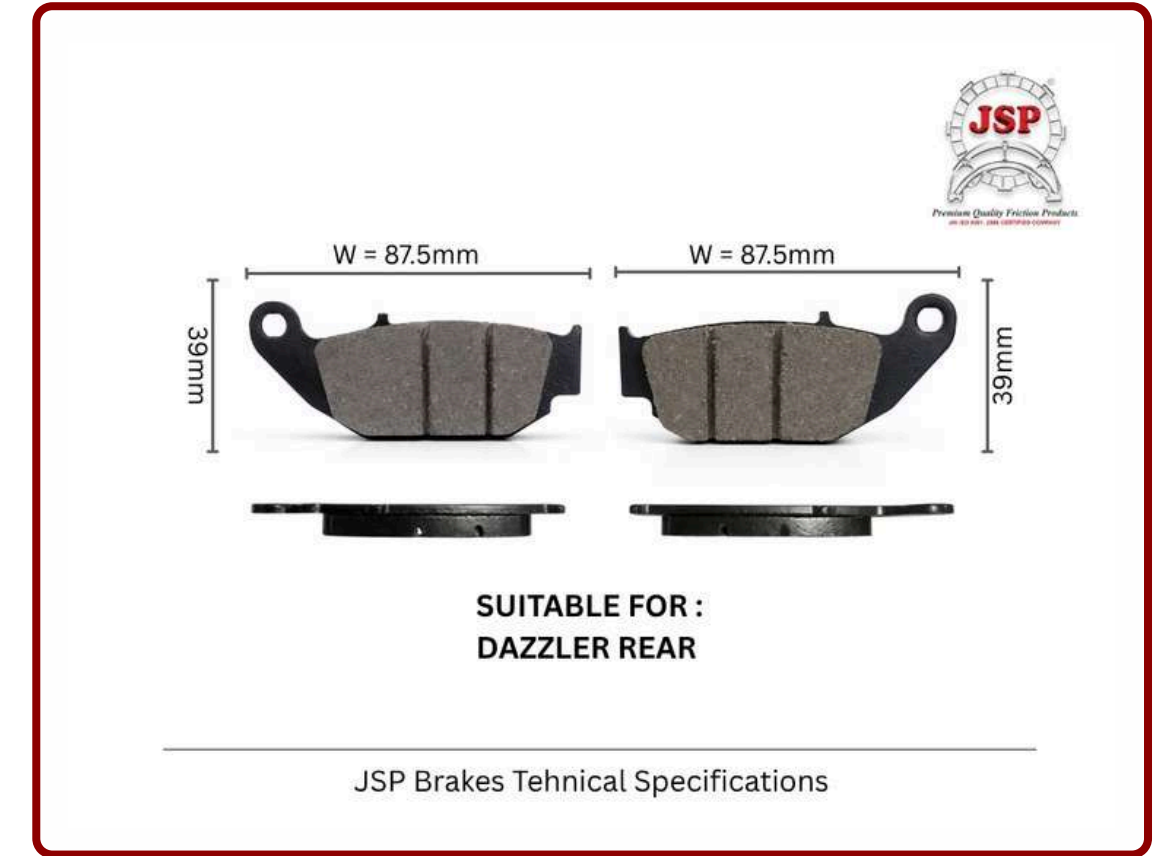

Compatible Models

GIXXER REAR



JSP BRAKES: ULTIMATE FRICTION TECHNOLOGY

High-Performance Disc Pad for 2W Applications

- NON-ASBESTOS, LOW METAL COMPOUND**
High Temperature Stability
Excellent Braking Performance
- V-SOLT HEAT EXPANSION GROOVE**
Reduces Heat Build-up,
Increases Brake Pad Life
- ROBUST CAST IRON BACKING PLATE**
High Rigidity, Enhanced
Durability
- Stable μ @ Elevated temperature**
LOW NVH
- HIGH-STRENGTH ADHESIVE BOND**
Zero DElamination, Strong Durability

PRECISION ENGINEERED | MAKE IN INDIA | LONG SERVICE LIFE



Compatible Models

GLAMOUR BS4



JSP BRAKES: ULTIMATE FRICTION TECHNOLOGY

High-Performance Disc Pad for 2W Applications

NON-ASBESTOS, LOW METAL COMPOUND
High Temperature Stability
Excellent Braking Performance

V-SOLT HEAT EXPANSION GROOVE
Reduces Heat Build-up,
Increases Brake Pad Life

Stable μ @ Elevated temperature
LOW NVH

ROBUST CAST IRON BACKING PLATE
High Rigidity, Enhanced Durability

HIGH-STRENGTH ADHESIVE BOND
Zero Delamination, Strong Durability

PRECISION ENGINEERED | MAKE IN INDIA | LONG SERVICE LIFE

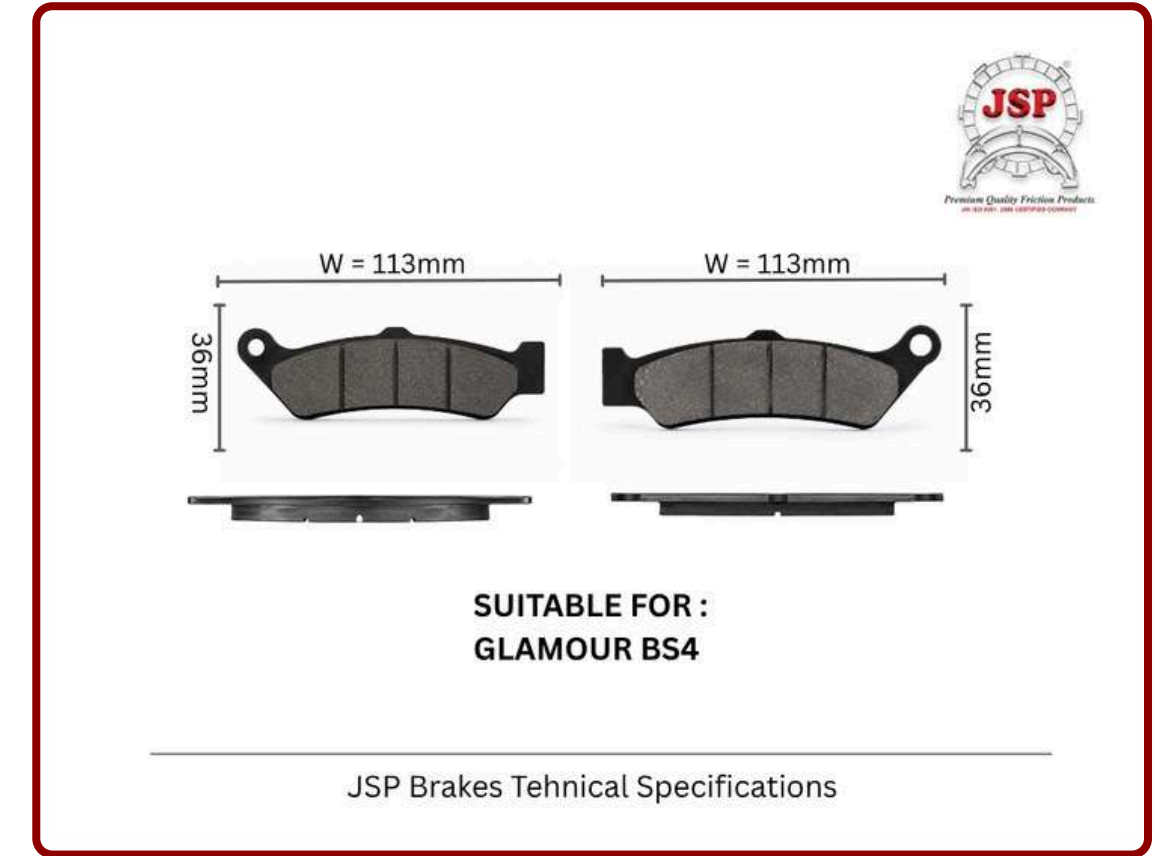

Compatible Models

PULSAR



JSP BRAKES: ULTIMATE FRICTION TECHNOLOGY

High-Performance Disc Pad for 2W Applications

- NON-ASBESTOS, LOW METAL COMPOUND**
High Temperature Stability
Excellent Braking Performance
- V-SOLT HEAT EXPANSION GROOVE**
Reduces Heat Build-up,
Increases Brake Pad Life
- Stable μ @ Elevated temperature**
LOW NVH
- ROBUST CAST IRON BACKING PLATE**
High Rigidity, Enhanced Durability
- HIGH-STRENGTH ADHESIVE BOND**
Zero DElamination, Strong Durability

PRECISION ENGINEERED | MAKE IN INDIA | LONG SERVICE LIFE

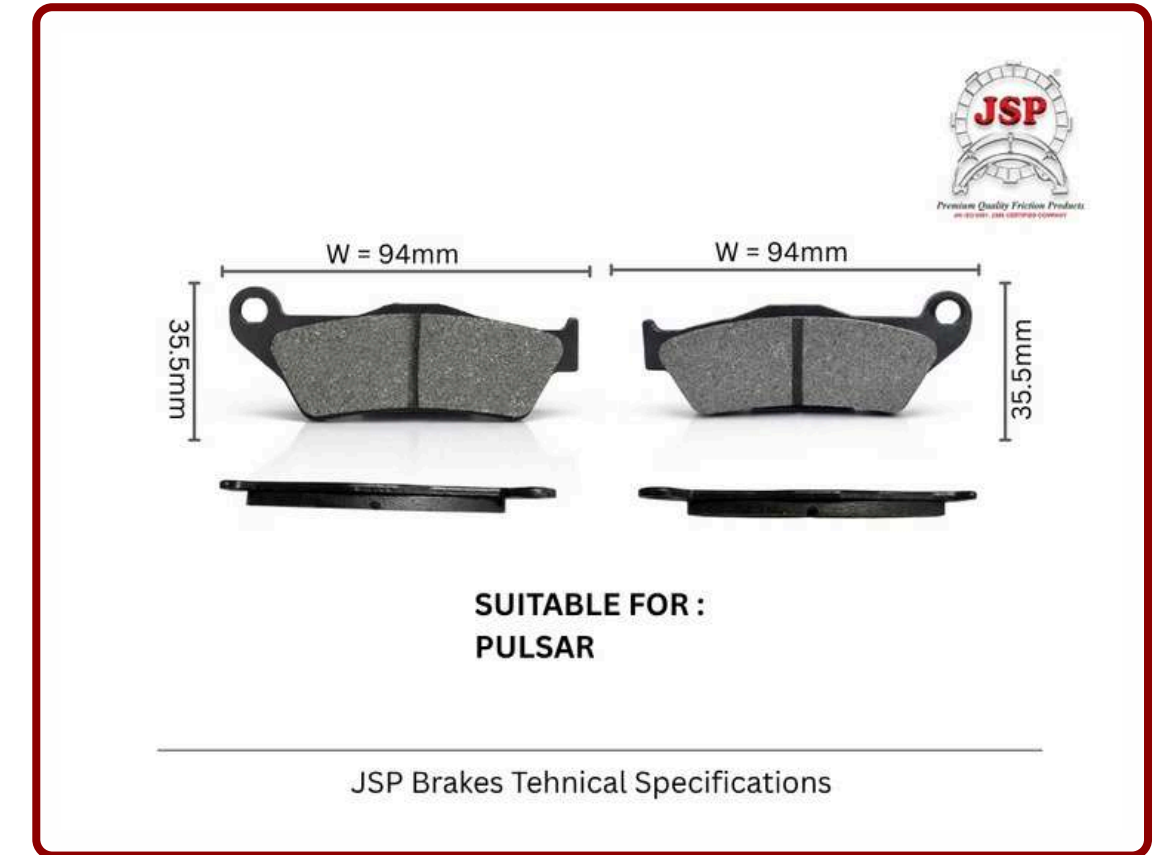

Compatible Models

R15 FRONT



JSP BRAKES: ULTIMATE FRICTION TECHNOLOGY

High-Performance Disc Pad for 2W Applications

NON-ASBESTOS, LOW METAL COMPOUND
High Temperature Stability
Excellent Braking Performance

Stable μ @ Elevated temperature
LOW NVH

V-SOLT HEAT EXPANSION GROOVE
Reduces Heat Build-up,
Increases Brake Pad Life

ROBUST CAST IRON BACKING PLATE
High Rigidity, Enhanced Durability

HIGH-STRENGTH ADHESIVE BOND
Zero DElamination, Strong Durability

PRECISION ENGINEERED | MAKE IN INDIA | LONG SERVICE LIFE

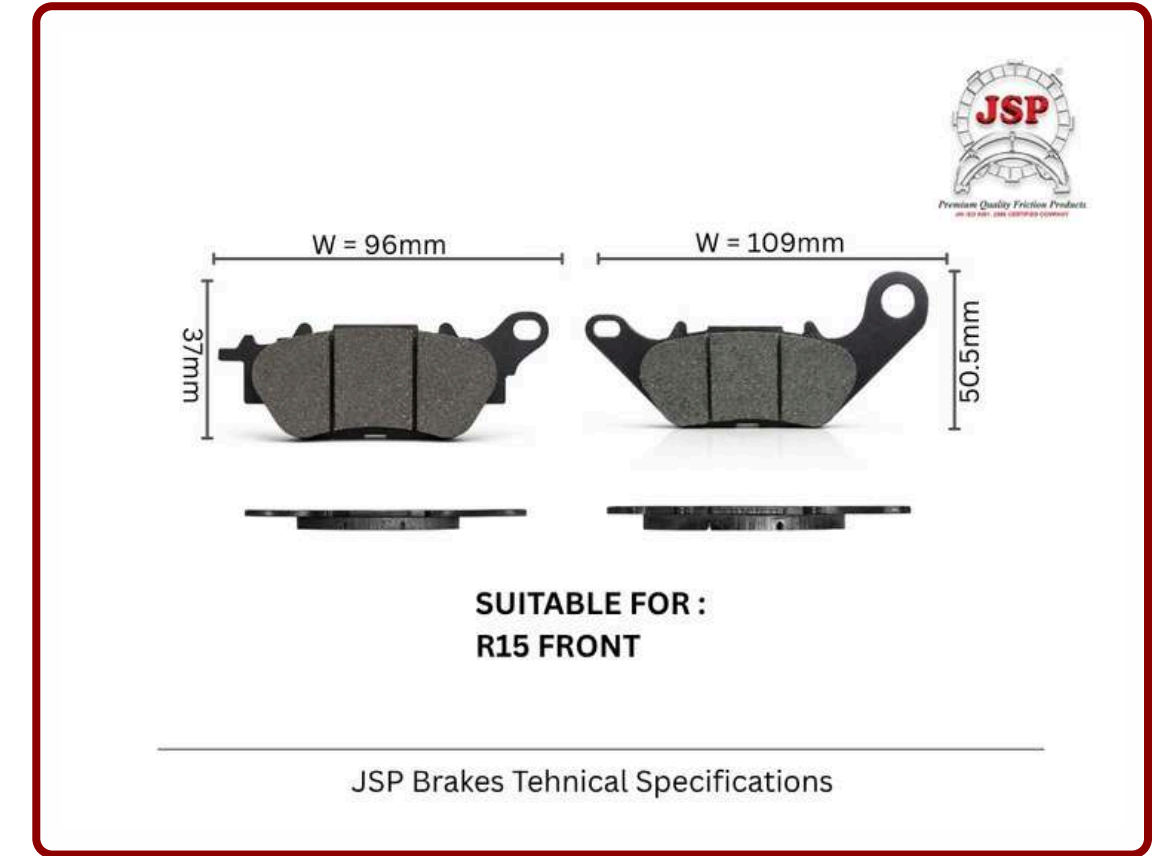

Compatible Models

R15



JSP BRAKES: ULTIMATE FRICTION TECHNOLOGY

High-Performance Disc Pad for 2W Applications

NON-ASBESTOS, LOW METAL COMPOUND
High Temperature Stability
Excellent Braking Performance

V-SOLT HEAT EXPANSION GROOVE
Reduces Heat Build-up,
Increases Brake Pad Life

Stable μ @ Elevated temperature
LOW NVH

ROBUST CAST IRON BACKING PLATE
High Rigidity, Enhanced Durability

HIGH-STRENGTH ADHESIVE BOND
Zero DElamination, Strong Durability

PRECISION ENGINEERED | MAKE IN INDIA | LONG SERVICE LIFE

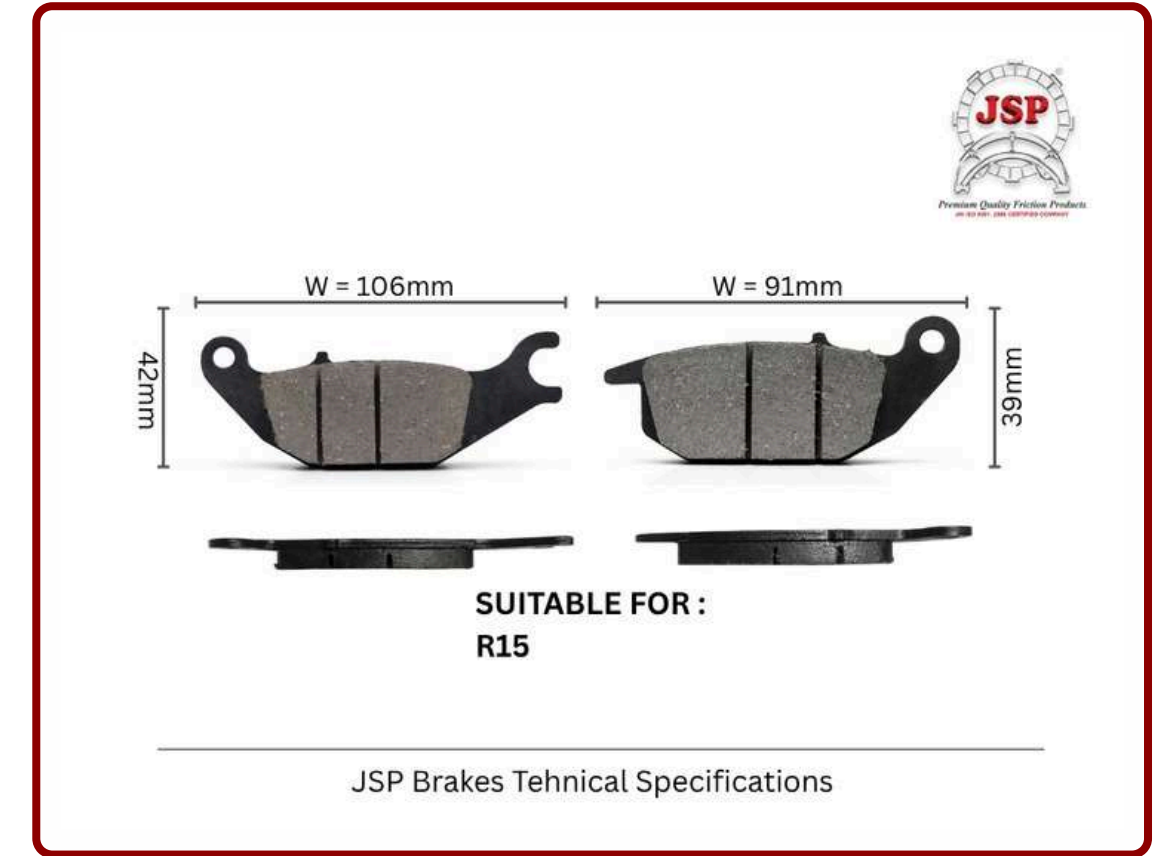

Compatible Models

SHINE N/M



JSP BRAKES: ULTIMATE FRICTION TECHNOLOGY

High-Performance Disc Pad for 2W Applications

NON-ASBESTOS, LOW METAL COMPOUND
High Temperature Stability
Excellent Braking Performance

V-SOLT HEAT EXPANSION GROOVE
Reduces Heat Build-up,
Increases Brake Pad Life

Stable μ @ Elevated temperature
LOW NVH

ROBUST CAST IRON BACKING PLATE
High Rigidity, Enhanced Durability

HIGH-STRENGTH ADHESIVE BOND
Zero Delamination, Strong Durability

PRECISION ENGINEERED | MAKE IN INDIA | LONG SERVICE LIFE

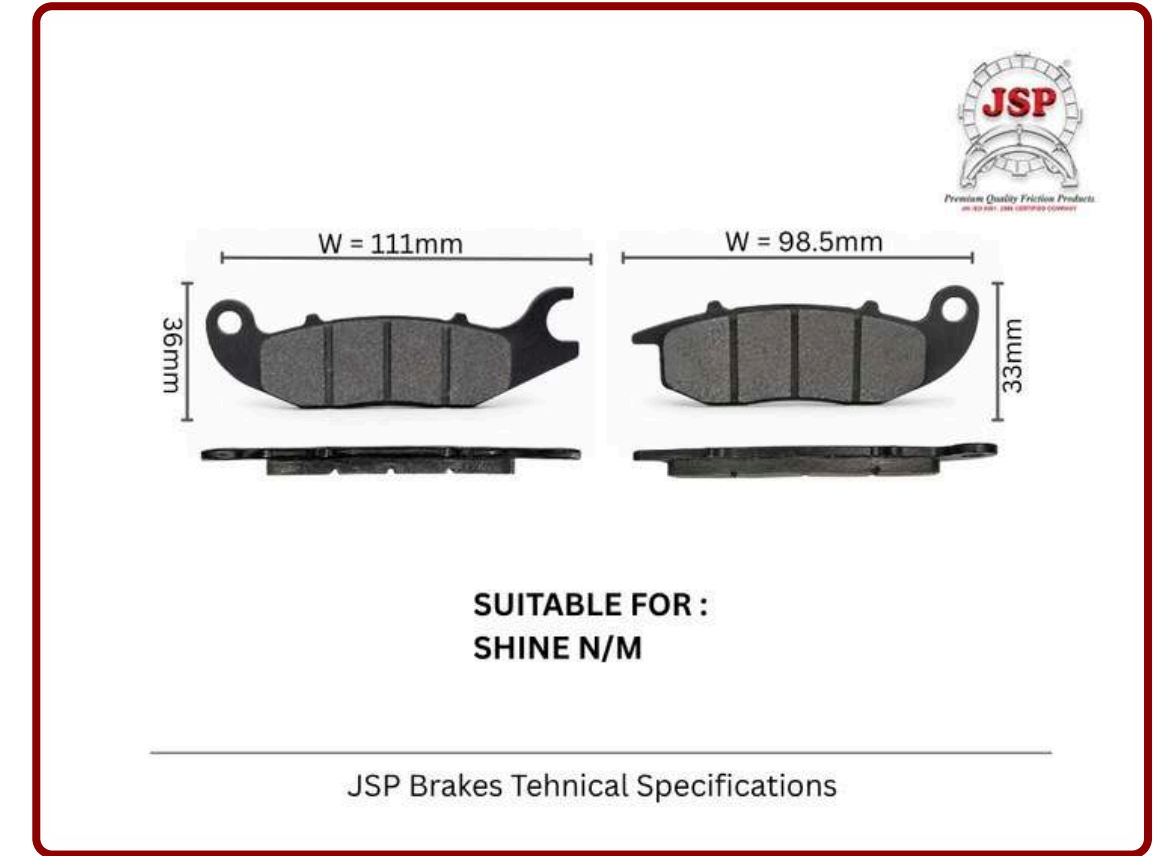

Compatible Models

SHINE SP BS6



JSP BRAKES: ULTIMATE FRICTION TECHNOLOGY

High-Performance Disc Pad for 2W Applications

NON-ASBESTOS, LOW METAL COMPOUND
High Temperature Stability
Excellent Braking Performance

V-SOLT HEAT EXPANSION GROOVE
Reduces Heat Build-up,
Increases Brake Pad Life

ROBUST CAST IRON BACKING PLATE
High Rigidity, Enhanced
Durability

Stable μ @ Elevated temperature
LOW NVH

HIGH-STRENGTH ADHESIVE BOND
Zero Delamination, Strong Durability

PRECISION ENGINEERED | MAKE IN INDIA | LONG SERVICE LIFE

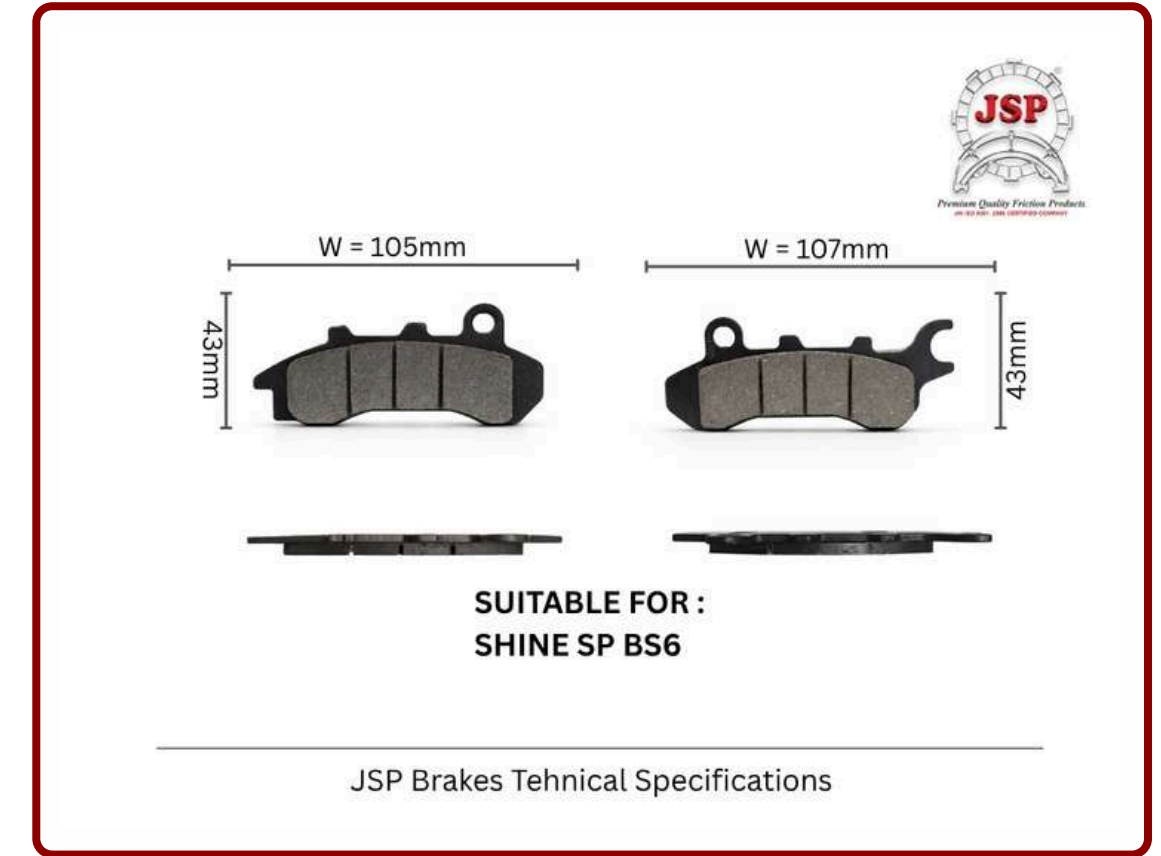

Compatible Models

SHINE SP



JSP BRAKES: ULTIMATE FRICTION TECHNOLOGY

High-Performance Disc Pad for 2W Applications

NON-ASBESTOS, LOW METAL COMPOUND
High Temperature Stability
Excellent Braking Performance

Stable μ @ Elevated temperature
LOW NVH

V-SOLT HEAT EXPANSION GROOVE
Reduces Heat Build-up,
Increases Brake Pad Life

ROBUST CAST IRON BACKING PLATE
High Rigidity, Enhanced
Durability

HIGH-STRENGTH ADHESIVE BOND
Zero DElamination, Strong Durability

PRECISION ENGINEERED | MAKE IN INDIA | LONG SERVICE LIFE



Compatible Models

UG 4



JSP BRAKES: ULTIMATE FRICTION TECHNOLOGY

High-Performance Disc Pad for 2W Applications

NON-ASBESTOS, LOW METAL COMPOUND
High Temperature Stability
Excellent Braking Performance

V-SOLT HEAT EXPANSION GROOVE
Reduces Heat Build-up,
Increases Brake Pad Life

Stable μ @ Elevated temperature
LOW NVH

ROBUST CAST IRON BACKING PLATE
High Rigidity, Enhanced Durability

HIGH-STRENGTH ADHESIVE BOND
Zero DElamination, Strong Durability

PRECISION ENGINEERED | MAKE IN INDIA | LONG SERVICE LIFE

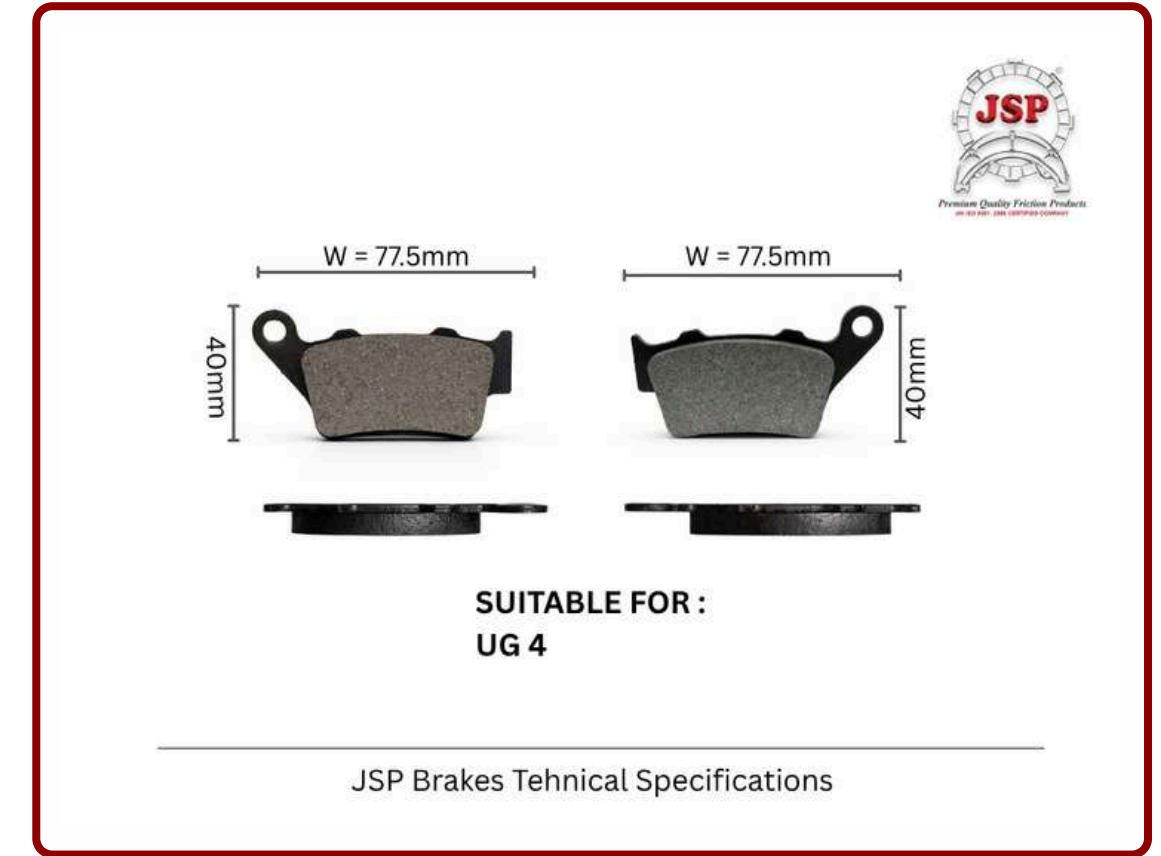

Compatible Models

UG 5



JSP BRAKES: ULTIMATE FRICTION TECHNOLOGY

High-Performance Disc Pad for 2W Applications

NON-ASBESTOS, LOW METAL COMPOUND
High Temperature Stability
Excellent Braking Performance

V-SOLT HEAT EXPANSION GROOVE
Reduces Heat Build-up,
Increases Brake Pad Life

ROBUST CAST IRON BACKING PLATE
High Rigidity, Enhanced
Durability

Stable μ @ Elevated temperature
LOW NVH

HIGH-STRENGTH ADHESIVE BOND
Zero DeLamination, Strong Durability

PRECISION ENGINEERED | MAKE IN INDIA | LONG SERVICE LIFE

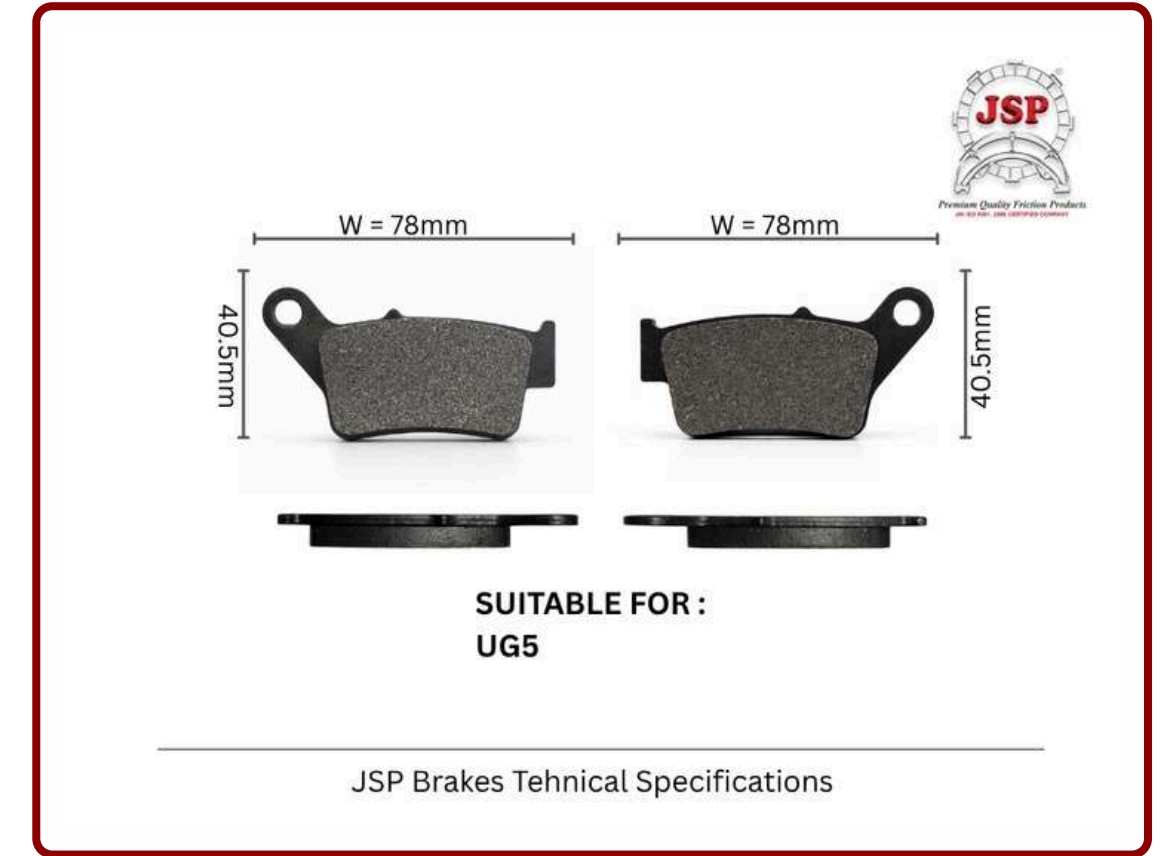

Compatible Models

UNOCORN



JSP BRAKES: ULTIMATE FRICTION TECHNOLOGY

High-Performance Disc Pad for 2W Applications

NON-ASBESTOS, LOW METAL COMPOUND
High Temperature Stability
Excellent Braking Performance

V-SOLT HEAT EXPANSION GROOVE
Reduces Heat Build-up,
Increases Brake Pad Life

Stable μ @ Elevated temperature
LOW NVH

ROBUST CAST IRON BACKING PLATE
High Rigidity, Enhanced Durability

HIGH-STRENGTH ADHESIVE BOND
Zero Delamination, Strong Durability

PRECISION ENGINEERED | **MAKE IN INDIA** | **LONG SERVICE LIFE**

JSP
Premium Quality Friction Products

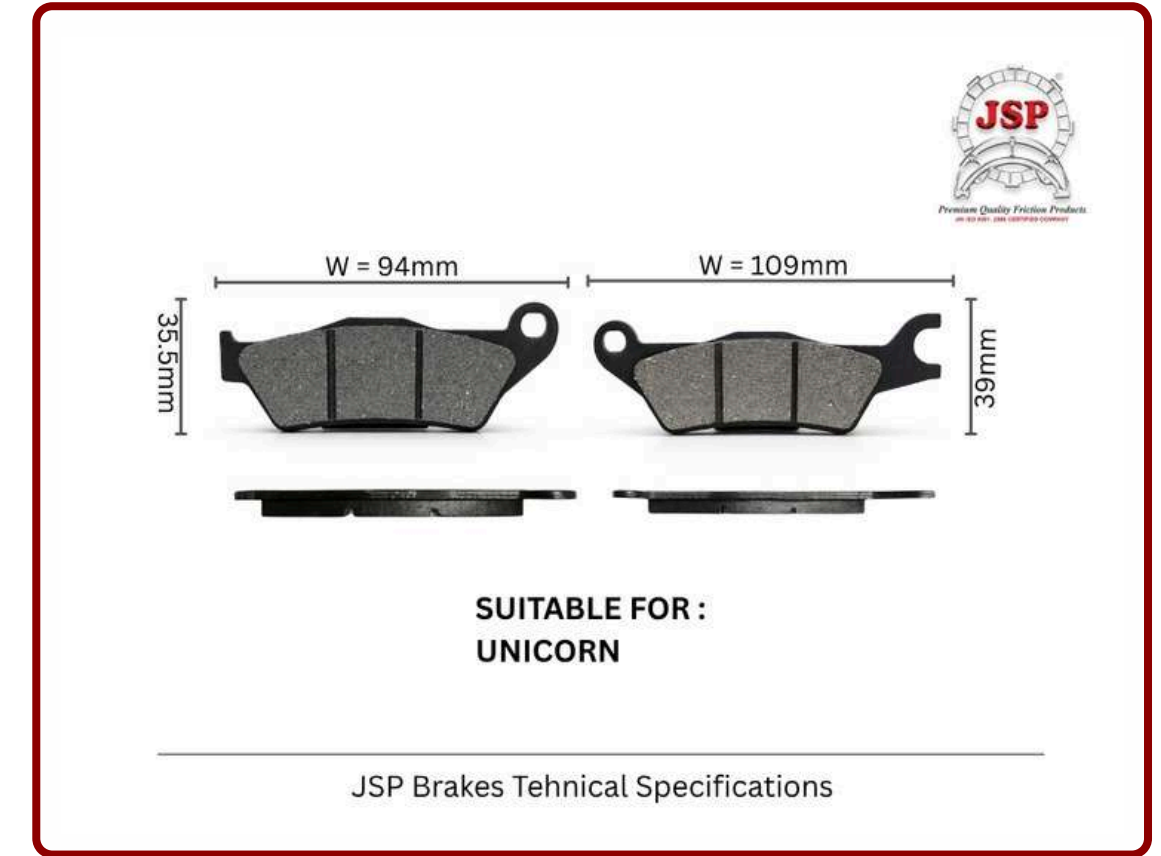

Compatible Models

V2 / V3



JSP BRAKES: ULTIMATE FRICTION TECHNOLOGY

High-Performance Disc Pad for 2W Applications

- NON-ASBESTOS, LOW METAL COMPOUND**
High Temperature Stability
Excellent Braking Performance
- V-SOLT HEAT EXPANSION GROOVE**
Reduces Heat Build-up,
Increases Brake Pad Life
- Stable μ @ Elevated temperature**
LOW NVH
- HIGH-STRENGTH ADHESIVE BOND**
Zero DElamination, Strong Durability
- ROBUST CAST IRON BACKING PLATE**
High Rigidity, Enhanced Durability

PRECISION ENGINEERED | MAKE IN INDIA | LONG SERVICE LIFE

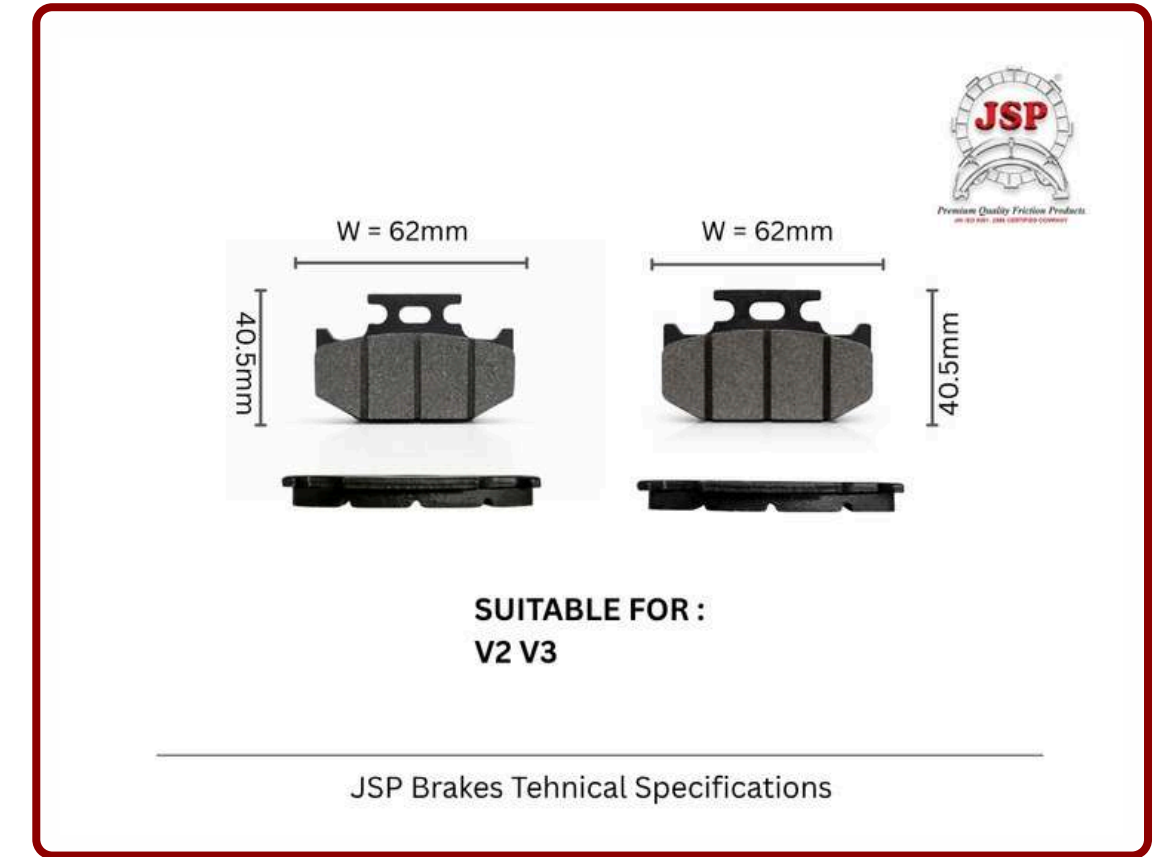

Compatible Models

YMH FZR FRONT



JSP BRAKES: ULTIMATE FRICTION TECHNOLOGY

High-Performance Disc Pad for 2W Applications

- NON-ASBESTOS, LOW METAL COMPOUND**
High Temperature Stability
Excellent Braking Performance
- V-SOLT HEAT EXPANSION GROOVE**
Reduces Heat Build-up,
Increases Brake Pad Life
- Stable μ @ Elevated temperature**
LOW NVH
- ROBUST CAST IRON BACKING PLATE**
High Rigidity, Enhanced Durability
- HIGH-STRENGTH ADHESIVE BOND**
Zero DElamination, Strong Durability

PRECISION ENGINEERED | **MAKE IN INDIA** | **LONG SERVICE LIFE**

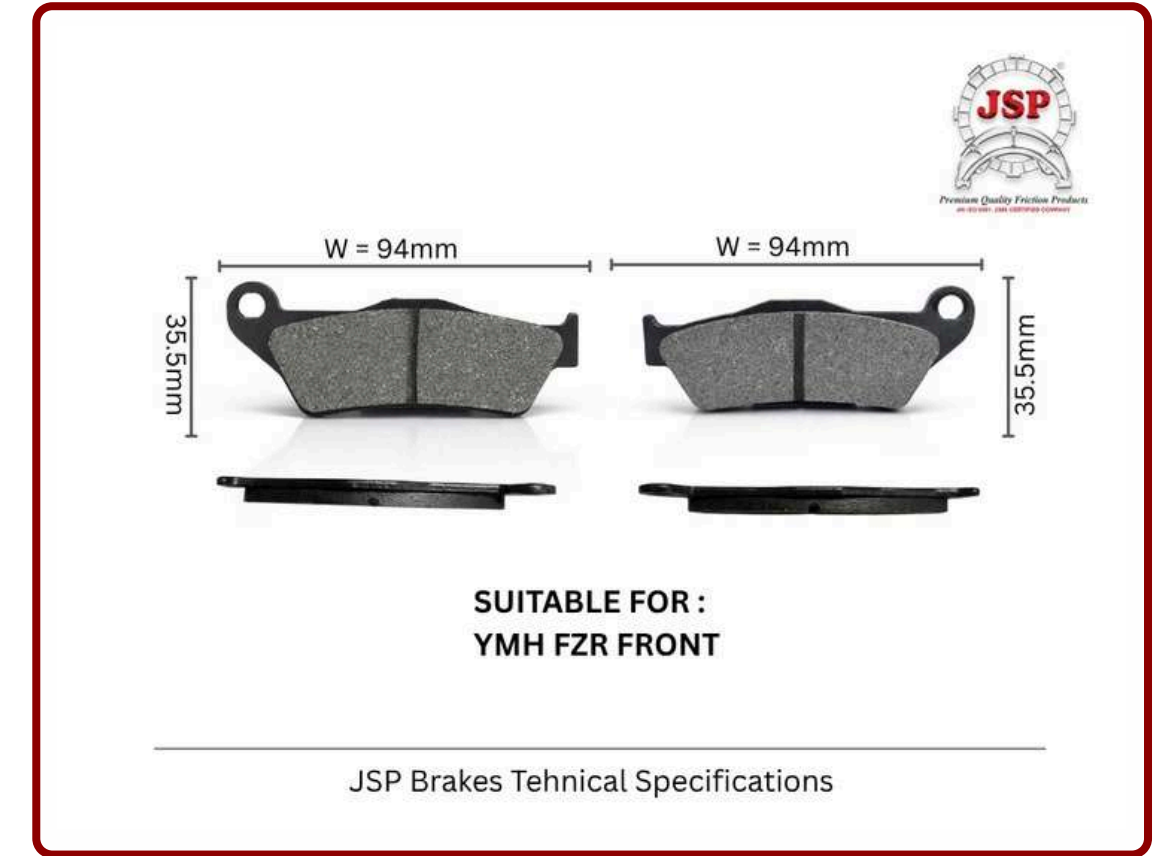

2W SCOOTER & EV RANGE

Next-Gen Braking Solutions for City Commutig

Designed for the modern city rider, JSP Scooter Disc Pads offer a smooth and silent braking experience. Optimized for stop-and-go traffic, our pads ensure maximum safety for both petrol Scooters and Electric Vehicles (EVs) with minimal lever effort.

PERFORMANCE FEATURES

Ultra-Smooth Lever Feel

Progressive Braking Response

Low-Effort Stopping Power

Perfect for Stop-and-Go Traffic

EV_Optimized Friction Material

Dust-Resistant & Clean Rims

Anti-Squeal Technology

Consistent Performance in All Weather

Compatible Models

ACCESS



JSP BRAKES: ULTIMATE FRICTION TECHNOLOGY

High-Performance Disc Pad for 2W Applications

NON-ASBESTOS, LOW METAL COMPOUND
High Temperature Stability
Excellent Braking Performance

V-SOLT HEAT EXPANSION GROOVE
Reduces Heat Build-up,
Increases Brake Pad Life

Stable μ @ Elevated temperature
LOW NVH

ROBUST CAST IRON BACKING PLATE
High Rigidity, Enhanced Durability

HIGH-STRENGTH ADHESIVE BOND
Zero DElamination, Strong Durability

PRECISION ENGINEERED | MAKE IN INDIA | LONG SERVICE LIFE



Compatible Models

ACTIVA BS6



JSP BRAKES: ULTIMATE FRICTION TECHNOLOGY

High-Performance Disc Pad for 2W Applications

NON-ASBESTOS, LOW METAL COMPOUND
High Temperature Stability
Excellent Braking Performance

V-SOLT HEAT EXPANSION GROOVE
Reduces Heat Build-up,
Increases Brake Pad Life

Stable μ @ Elevated temperature
LOW NVH

ROBUST CAST IRON BACKING PLATE
High Rigidity, Enhanced Durability

HIGH-STRENGTH ADHESIVE BOND
Zero DElamination, Strong Durability

PRECISION ENGINEERED | MAKE IN INDIA | LONG SERVICE LIFE

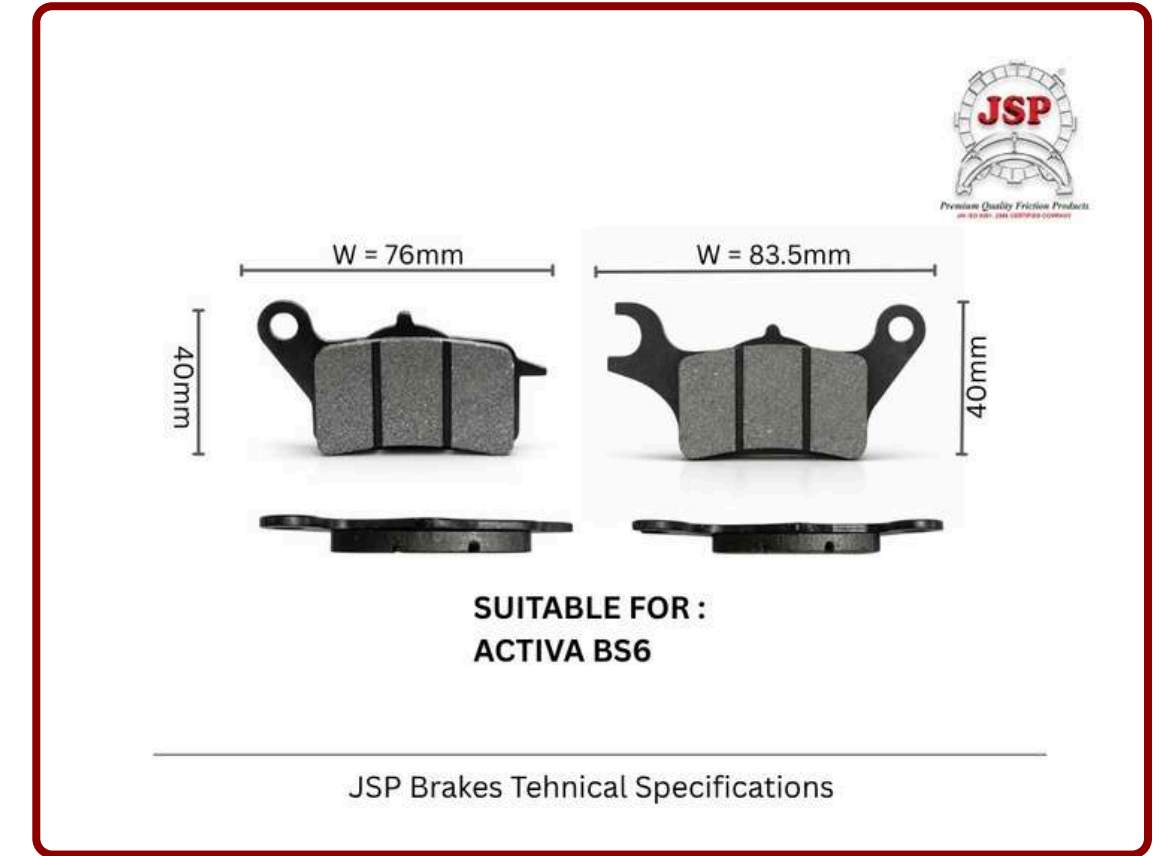

Compatible Models

AETHER FRONT



JSP BRAKES: ULTIMATE FRICTION TECHNOLOGY

High-Performance Disc Pad for 2W Applications

NON-ASBESTOS, LOW METAL COMPOUND
High Temperature Stability
Excellent Braking Performance

V-SOLT HEAT EXPANSION GROOVE
Reduces Heat Build-up,
Increases Brake Pad Life

Stable μ @ Elevated temperature
LOW NVH

ROBUST CAST IRON BACKING PLATE
High Rigidity, Enhanced Durability

HIGH-STRENGTH ADHESIVE BOND
Zero Delamination, Strong Durability

PRECISION ENGINEERED | MAKE IN INDIA | LONG SERVICE LIFE

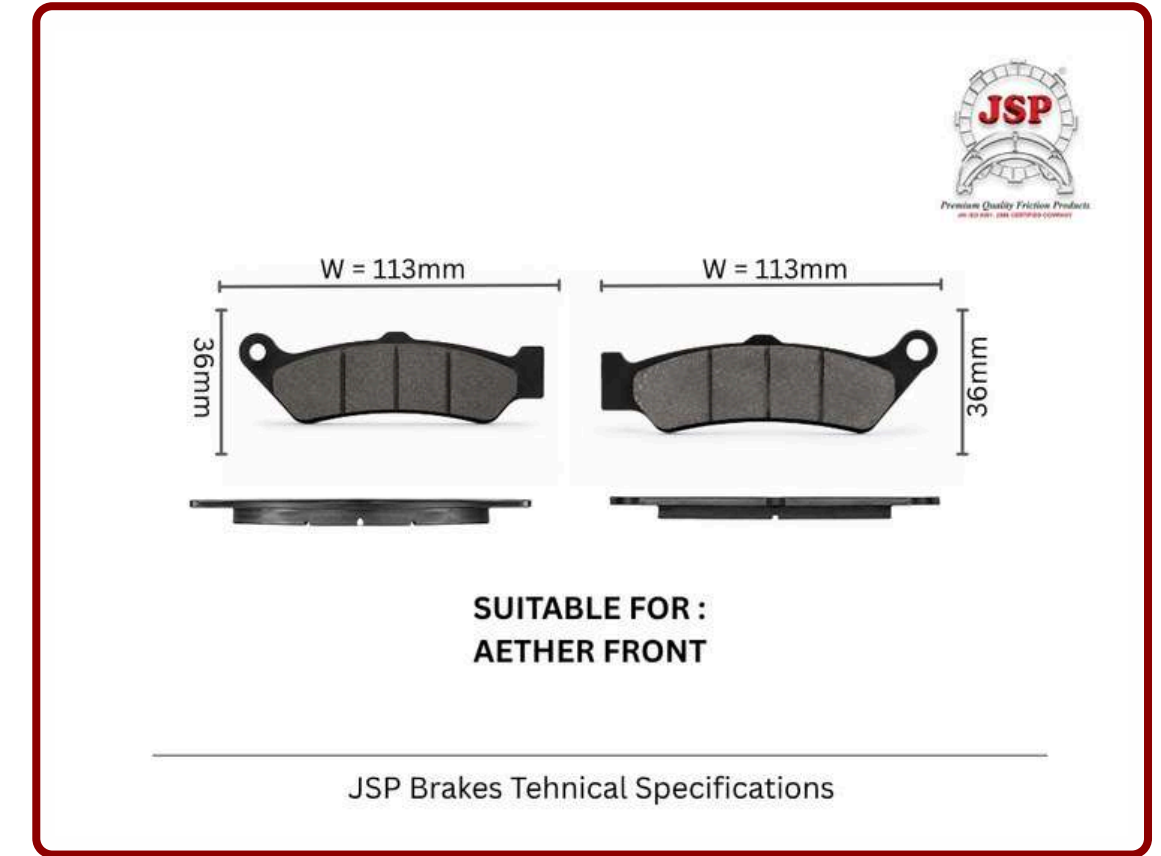

Compatible Models

AETHER REAR



JSP BRAKES: ULTIMATE FRICTION TECHNOLOGY

High-Performance Disc Pad for 2W Applications

- NON-ASBESTOS, LOW METAL COMPOUND**
High Temperature Stability
Excellent Braking Performance
- V-SOLT HEAT EXPANSION GROOVE**
Reduces Heat Build-up,
Increases Brake Pad Life
- ROBUST CAST IRON BACKING PLATE**
High Rigidity, Enhanced Durability
- Stable μ @ Elevated temperature**
LOW NVH
- HIGH-STRENGTH ADHESIVE BOND**
Zero DElamination, Strong Durability

PRECISION ENGINEERED | MAKE IN INDIA | LONG SERVICE LIFE



Compatible Models

CHETAK ELECTRIC FRONT



JSP BRAKES: ULTIMATE FRICTION TECHNOLOGY

High-Performance Disc Pad for 2W Applications

- NON-ASBESTOS, LOW METAL COMPOUND**
High Temperature Stability
Excellent Braking Performance
- V-SOLT HEAT EXPANSION GROOVE**
Reduces Heat Build-up,
Increases Brake Pad Life
- ROBUST CAST IRON BACKING PLATE**
High Rigidity, Enhanced Durability
- Stable μ @ Elevated temperature**
LOW NVH
- HIGH-STRENGTH ADHESIVE BOND**
Zero DElamination, Strong Durability

PRECISION ENGINEERED | MAKE IN INDIA | LONG SERVICE LIFE

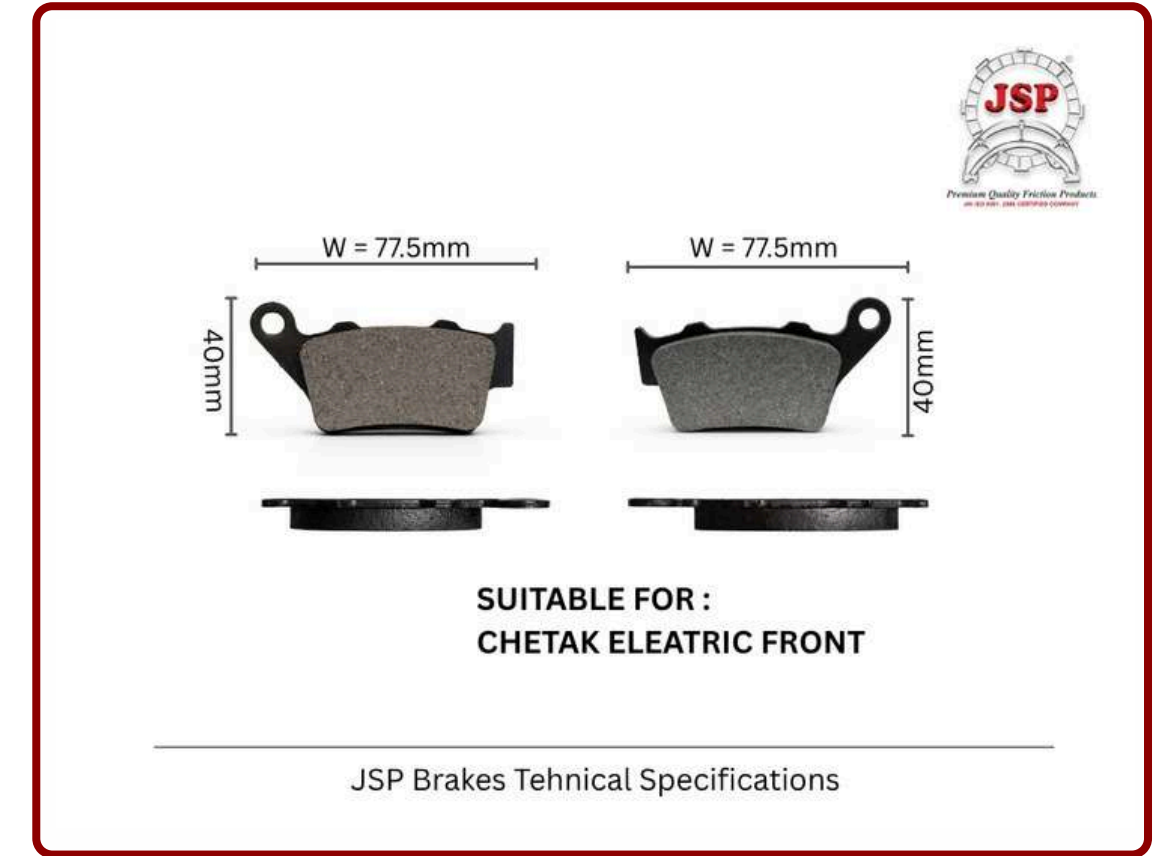

Compatible Models

EV 1



JSP BRAKES: ULTIMATE FRICTION TECHNOLOGY

High-Performance Disc Pad for 2W Applications

The diagram shows a brake pad with several callout boxes pointing to specific features:

- NON-ASBESTOS, LOW METAL COMPOUND**
High Temperature Stability
Excellent Braking Performance
- V-SOLT HEAT EXPANSION GROOVE**
Reduces Heat Build-up,
Increases Brake Pad Life
- Stable μ @ Elevated temperature**
- LOW NVH**
- ROBUST CAST IRON BACKING PLATE**
High Rigidity, Enhanced Durability
- HIGH-STRENGTH ADHESIVE BOND**
Zero Delamination, Strong Durability

At the bottom, there are three icons with text: a gear for "PRECISION ENGINEERED", a globe for "MAKE IN INDIA", and a calendar for "LONG SERVICE LIFE".

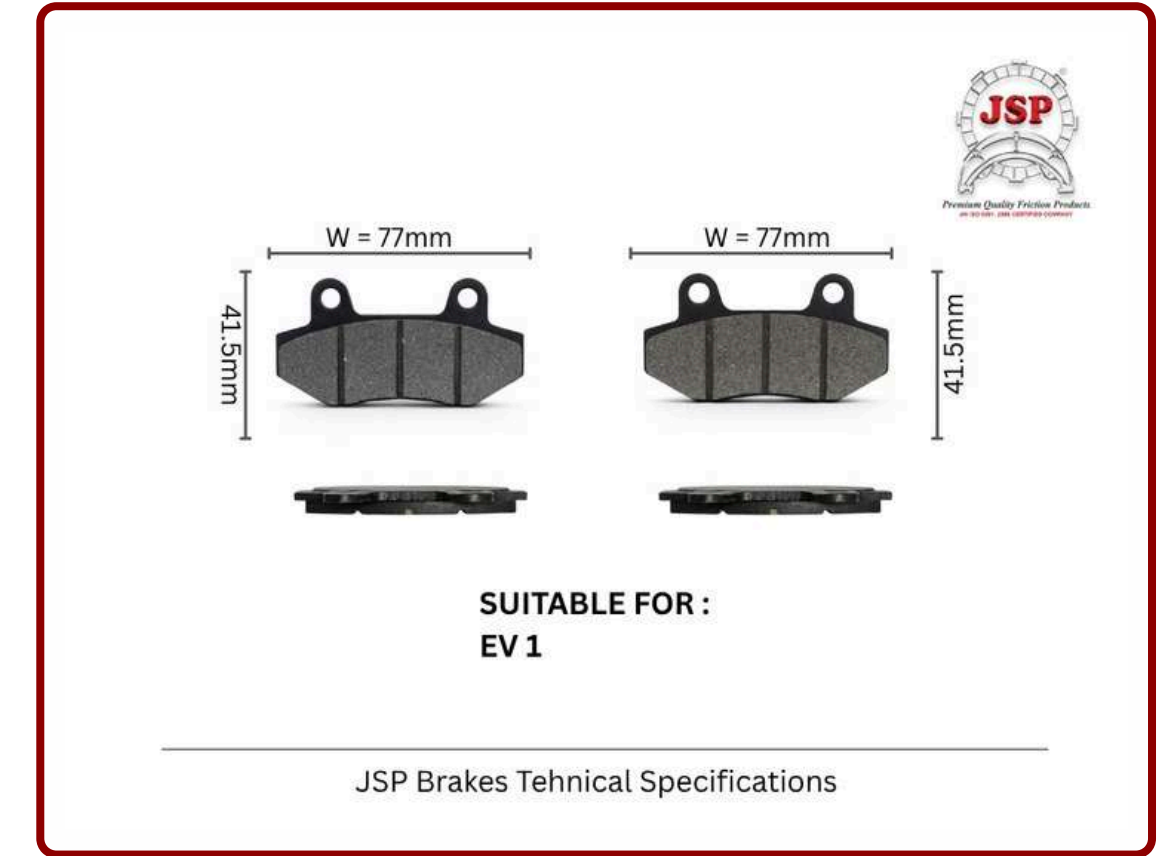

Compatible Models

JUPITER



JSP BRAKES: ULTIMATE FRICTION TECHNOLOGY

High-Performance Disc Pad for 2W Applications

NON-ASBESTOS, LOW METAL COMPOUND
High Temperature Stability
Excellent Braking Performance

V-SOLT HEAT EXPANSION GROOVE
Reduces Heat Build-up,
Increases Brake Pad Life

ROBUST CAST IRON BACKING PLATE
High Rigidity, Enhanced Durability

Stable μ @ Elevated temperature
LOW NVH

HIGH-STRENGTH ADHESIVE BOND
Zero DElamination, Strong Durability

PRECISION ENGINEERED | **MAKE IN INDIA** | **LONG SERVICE LIFE**

JSP
Premium Quality Friction Products

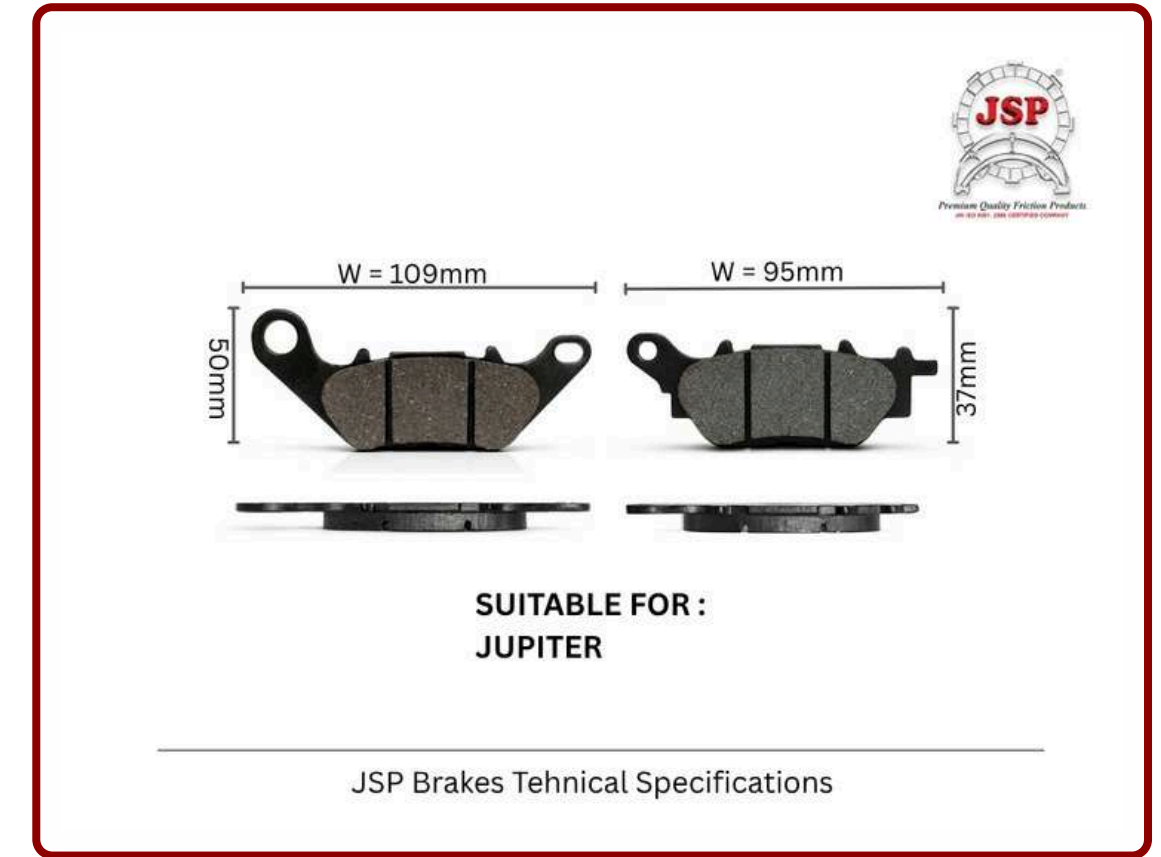

Compatible Models

OLA FRONT



JSP BRAKES: ULTIMATE FRICTION TECHNOLOGY
High-Performance Disc Pad for 2W Applications

NON-ASBESTOS, LOW METAL COMPOUND
High Temperature Stability
Excellent Braking Performance

Stable μ @ Elevated temperature
LOW NVH

ROBUST CAST IRON BACKING PLATE
High Rigidity, Enhanced Durability

V-SOLT HEAT EXPANSION GROOVE
Reduces Heat Build-up,
Increases Brake Pad Life

HIGH-STRENGTH ADHESIVE BOND
Zero Delamination, Strong Durability

PRECISION ENGINEERED | MAKE IN INDIA | LONG SERVICE LIFE

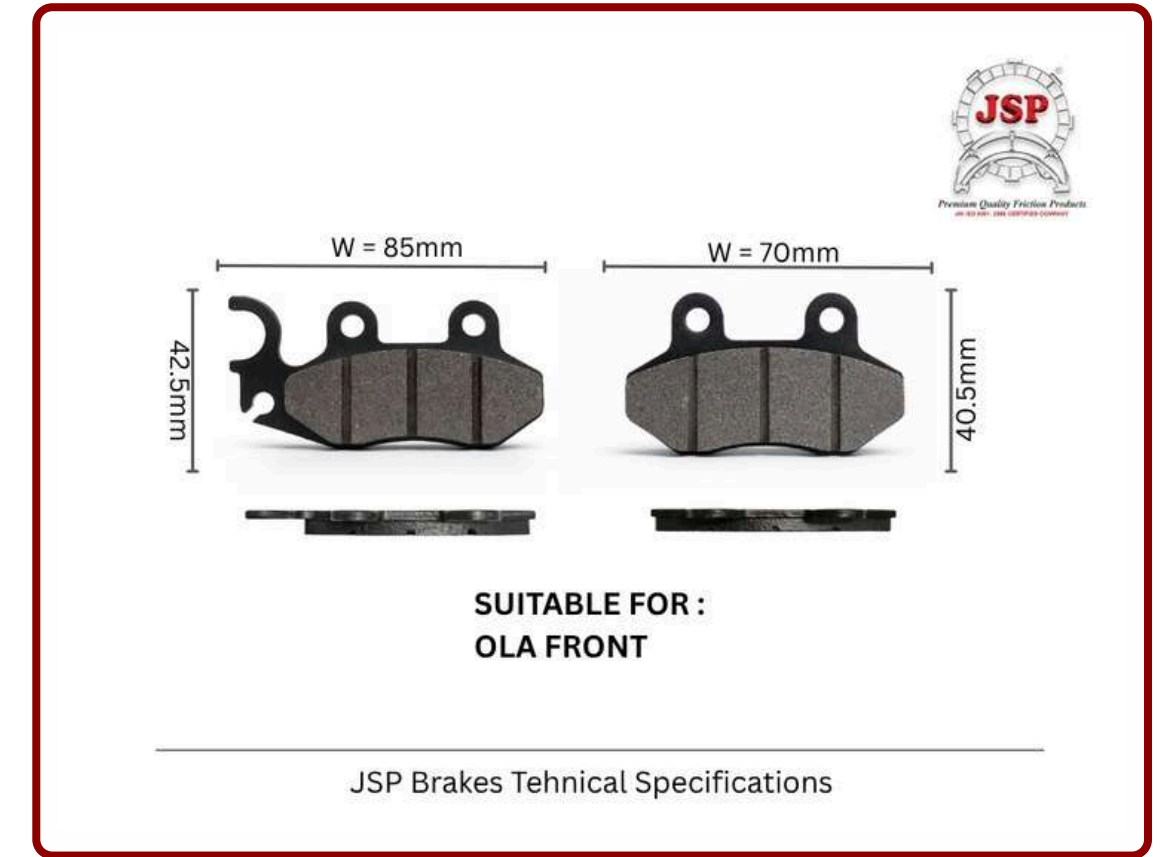

Compatible Models

OLA REAR



JSP BRAKES: ULTIMATE FRICTION TECHNOLOGY

High-Performance Disc Pad for 2W Applications

- NON-ASBESTOS, LOW METAL COMPOUND**
High Temperature Stability
Excellent Braking Performance
- Stable μ @ Elevated temperature**
LOW NVH
- V-SOLT HEAT EXPANSION GROOVE**
Reduces Heat Build-up,
Increases Brake Pad Life
- ROBUST CAST IRON BACKING PLATE**
High Rigidity, Enhanced Durability
- HIGH-STRENGTH ADHESIVE BOND**
Zero Delamination, Strong Durability

PRECISION ENGINEERED | MAKE IN INDIA | LONG SERVICE LIFE



Compatible Models

RAY BS6



JSP BRAKES: ULTIMATE FRICTION TECHNOLOGY

High-Performance Disc Pad for 2W Applications

NON-ASBESTOS, LOW METAL COMPOUND
High Temperature Stability
Excellent Braking Performance

V-SOLT HEAT EXPANSION GROOVE
Reduces Heat Build-up,
Increases Brake Pad Life

**Stable μ @ Elevated temperature
LOW NVH**

ROBUST CAST IRON BACKING PLATE
High Rigidity, Enhanced Durability

HIGH-STRENGTH ADHESIVE BOND
Zero Delamination, Strong Durability

PRECISION ENGINEERED | MAKE IN INDIA | LONG SERVICE LIFE

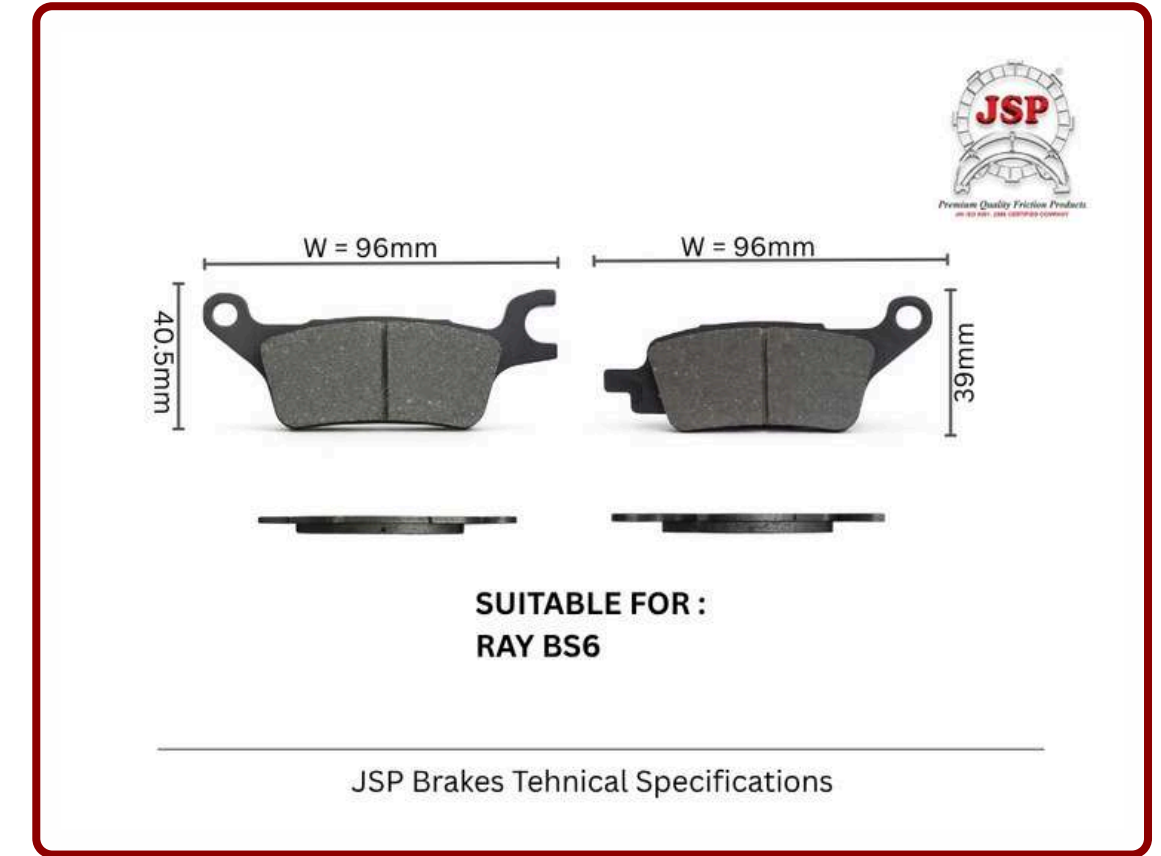

Compatible Models

TVS I-Q



JSP BRAKES: ULTIMATE FRICTION TECHNOLOGY

High-Performance Disc Pad for 2W Applications

NON-ASBESTOS, LOW METAL COMPOUND
High Temperature Stability
Excellent Braking Performance

V-SOLT HEAT EXPANSION GROOVE
Reduces Heat Build-up,
Increases Brake Pad Life

Stable μ @ Elevated temperature
LOW NVH

ROBUST CAST IRON BACKING PLATE
High Rigidity, Enhanced Durability

HIGH-STRENGTH ADHESIVE BOND
Zero DeLamination, Strong Durability

PRECISION ENGINEERED | MAKE IN INDIA | LONG SERVICE LIFE

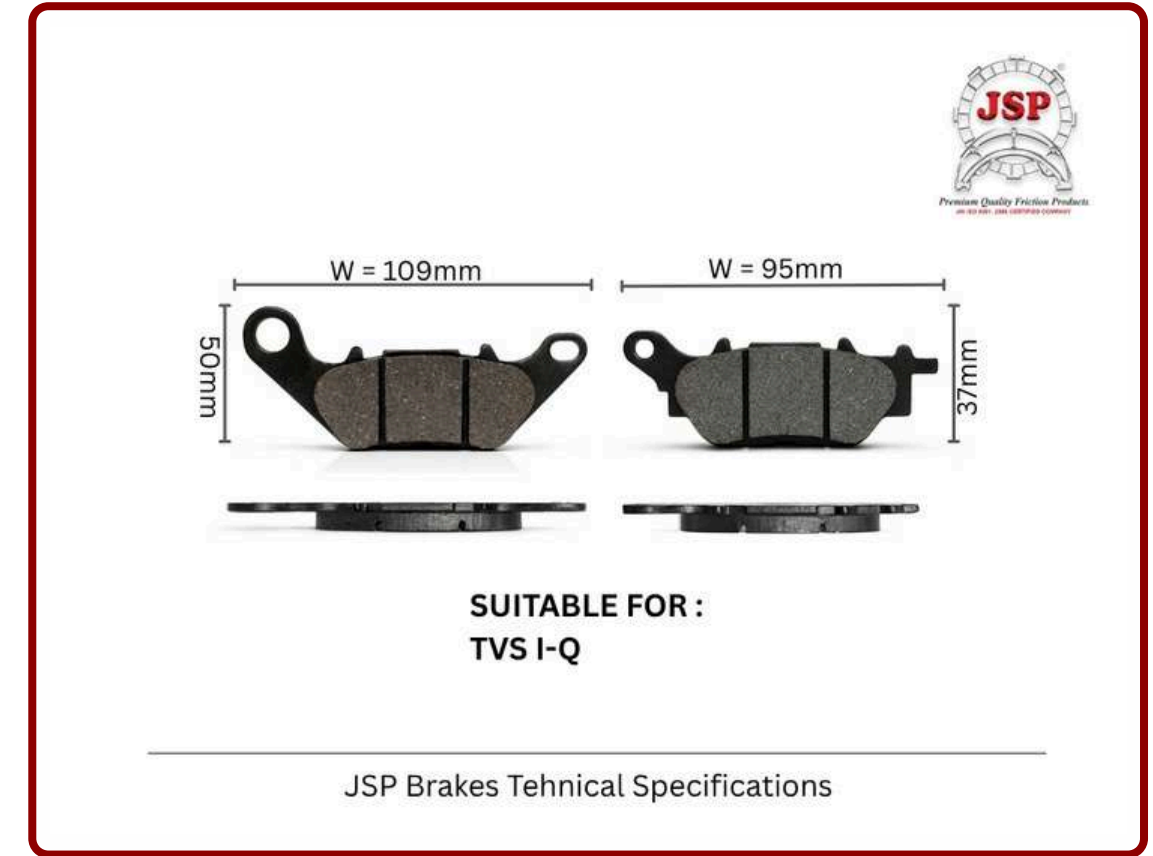

Contact us

 +91 98718 44900
+91 93101 70240

 info@jspbrakes.com

 jspbrakes.com

 Shed No-9 Cat II, DSIDC Complex,
Rohtak Road, New Delhi-41

Stay Connected with JSP



EXPLORE OUR COMPLETE RANGE

CLICK HERE





Premium Quality Friction Products
AN ISO 9001: 2008 CERTIFIED COMPANY

***JSP Brakes
& Clutches***
THANK YOU